

成品製造管制圖

DRAWING OF FINISHED PRODUCTS

禁止使用1級環境管理物質
Non-use Warranty for Level 1
Prohibited Substances in Product.

Pich 3.96mm
間距 (.156")

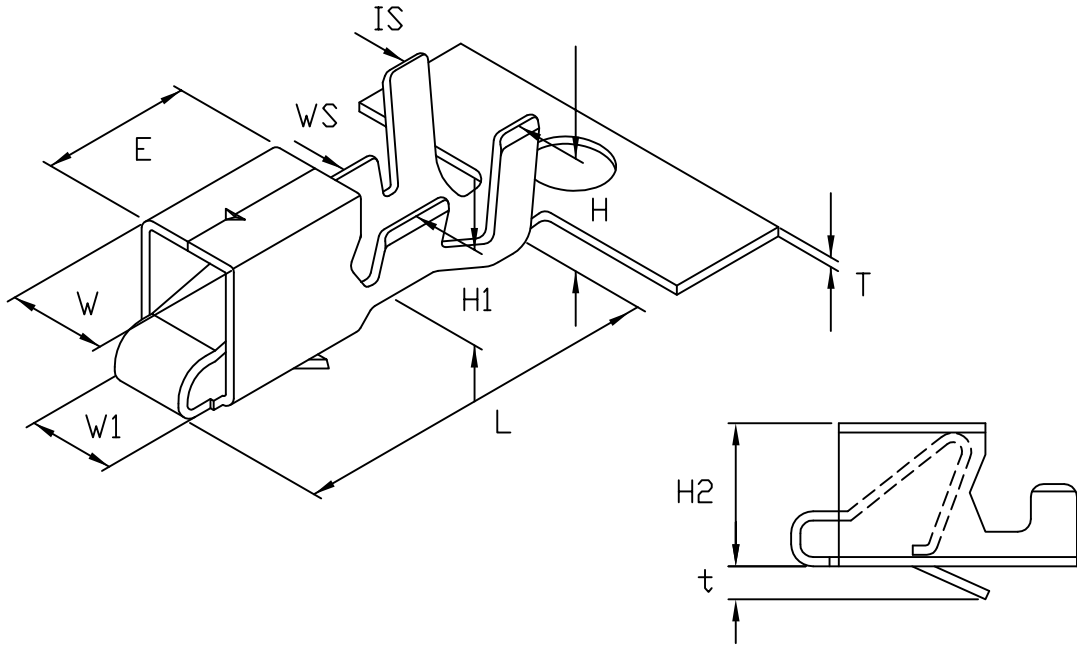

產品編號 Part No: MCN-3101-0004
品名 Product: 端子 TERMINAL
材質 Material: Brass/Phos
材料厚度 Thickness: 0.25mm
包裝數量 Standard Packing: 4000PCS
適用電線 Suitable Wire: 18~22AWG

DIMENSION:(MM)

T:0.25 ± 0.03
L:10.6 ± 0.3
E:4.0 ± 0.25
W:3.0 ± 0.15
W1:2.0 ± 0.15
IS:4.0 ± 0.35
WS:2.6 ± 0.3
H:3.7 ± 0.35
H1:2.4 ± 0.3
H2:3.8 ± 0.15
t:1.0 ± 0.2

表面處理 Treatment: -0 無表面處理, -00 鍍金, -1 鍍鎳, -2 鍍錫
(-0 Non surface treatment
, -00 Gold flash, -1 Nickel played, -2 Tin plated)

* 本成品圖僅供參考, 若需做為承認用請聯絡就近業務員確認
(The drawing is for reference only,
please contact the sales division nearby for final confirmation if it's for approval purpose.)